

511/521/522

ALUMINUM DOOR SYSTEMS



ALUMINUM SECTIONAL DOORS



**VISUAL ACCESS.
LIGHT INFILTRATION.
CONTEMPORARY LOOK.**



INDUSTRY LEADING
COMMERCIAL & INDUSTRIAL SOLUTIONS



Model 511, Brown powder coat finish, Clear glass

General features and benefits – Models 511/521

- 1 3/4" (45 mm) thick, corrosion-resistant 6063-T6 aluminum sections with galvanized fixtures and hinges promotes durability and trouble-free operation
- 1/4" (6 mm) diameter through-rods on all stiles and rails enhances strength and sturdiness
- Top-quality materials, excellent field service and optional maintenance program contribute to extended door life, low maintenance costs and maximum productivity
- Glazing choices include DSB glass, acrylic, tempered glass, clear polycarbonate, multi-wall polycarbonate, wire glass, Low E, Lexan and laminate
- Standard clear anodized finish for low-maintenance and corrosion-resistance
- Optional finishes include a wide range of powder coat colors offering an attractive and durable finish
- Manual pull rope operation with optional chain hoist or electric motor operator
- Available in approximately 200 RAL powder coat colors to match the aesthetic and design of your project. This color optional upgrade includes a hardening additive that provides an attractive and durable finish and easy-to-clean surface.

Cover image: Model 521, Clear anodized finish with Clear glass.



Model 522, Mirrored Gray glass

General features and benefits – Model 522

- **Frameless design** – the ultimate sleek and modern aluminum full-view door
- **Vinyl seals** between the sections and the flexible bottom seal help to minimize air flow
- **Large glass panels**, mounted to the front of the door, allow maximum light and visibility
- **1 3/8" thick aluminum section** with patent pending design for long life and durability
- **2 1/4" integrated reinforcing rib** on upper intermediate rail for doors 10'3" wide and over
- **Meets ASHRAE 90.1 and IECC® air infiltration requirements** with a third-party tested value of less than 0.4 cfm/ft²
- **Meets California Code of Regulation, Title 24 air infiltration requirements** with a third-party tested value of less than 0.3 cfm/ft²



ALUMINUM DOOR SYSTEMS

MODELS 511/521/522 offer an attractive solution for commercial and industrial applications where visual access, light infiltration and aesthetics are key design considerations.

Model 521, Clear anodized finish with Clear glass



Glass options for Models 511/521

Specialty Glass

- Laminated White – privacy
- Low E Glass** – thermal efficiency
- Tempered Glass – enhanced safety
- Tinted Glass** – color options:
Green, Gray, Bronze

Glass alternatives

- Clear Lexan® Polycarbonate** – shatter resistant
- Multi Wall Polycarbonate – superior strength with UV protection; color options: Clear, White, Bronze
- Plexiglas® Acrylic** – shatter resistant
- Impact Clear and Frosted Polycarbonate - 0.250" minimum



Double Strength DSB** (Standard)

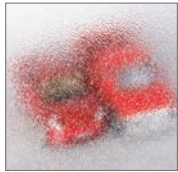

Obscure



Satin Etched



Gray Tint



Green Tint



Bronze Tint



Impact Frosted Polycarbonate

Actual glass may vary from brochure photos due to fluctuations in the printing process. Check with your Overhead Door™ Distributor to view a glass sample.

** Insulated options available.



Model 511, Clear Anodized finish with Clear glass

ALUMINUM DOOR SYSTEMS MODEL 511

doors are designed in sizes up to 16'2" wide and 16'1" high (4928 mm and 4902 mm). Featuring a narrow center stile width of 21/32" (17 mm), these doors are sleek, attractive and permit maximum visibility. An array of glazing choices, top and bottom rail widths, finishes and special options customizes the 511 Model to satisfy nearly any project requirement.

Model 511, Black powder coat finish, Clear glass.



Standard features at a glance

Panel thickness	1 3/4" (45 mm)
Maximum standard height	16'1" (4902 mm)
Maximum standard width	16'2" (6147 mm)
Material	6063-T6 aluminum
Standard finish	204R-1 clear anodized
Center stile width	2 1/32" (17 mm)
End stile width	2 3/4" (70 mm)
Top rail width	2 3/8" (60 mm) or 3 3/4" (95 mm)
Top intermediate rail width	3/4" (19 mm)
Bottom intermediate rail width	5/8" (16 mm)
Bottom rail width	2 3/8" (60 mm) or 3 3/4" (95 mm) or 4 1/2" (114 mm)
Weatherseals	Bottom, flexible PVC
Standard springs	10,000 cycle
Track	2" (51 mm)
Mounting	Angle
Operation	Manual pull rope
Hinges and fixtures	Galvanized steel
Lock	Galvanized, interior-mounted single unit
Warranty	1-Year Limited; 3-Year Limited powder coat finish

Options

Glazing options*:
 1/8" (3 mm) DSB;
 1/8" (3 mm) or 1/4" (6 mm) acrylic;
 1/8" (3 mm) or 1/4" (6 mm) tempered;
 1/8" (3 mm) or 1/4" (6 mm) clear polycarbonate;
 1/4" (6mm) and 3/8" twin-wall polycarbonate, 5/8" triple-wall polycarbonate;
 1/4" (6 mm) 3/8" (10 mm) and 5/8" (16 mm) twin-wall polycarbonate, triple-wall polycarbonate 1/4" (6 mm) wire glass;
 1/2" (12 mm) insulated glass

Electric operator or chain hoist

Bottom sensing edge

3" track

Bracket mounting (not available on full vertical door tracks)

Higher-cycle springs in 25k, 50k, 75k, 100k cycles

Chain hoist

Posi-tension drums

*Contact your local Overhead Door™ Distributor for special glazing requirements. Verify 1/4" (6 mm) glass applications with factory.

Structure options

Anodized finishes



Clear (standard)

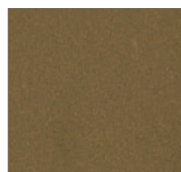

Light Bronze

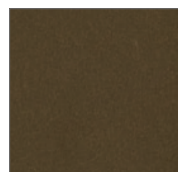

Medium Bronze

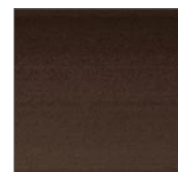

Dark Bronze

Powder coat finishes

Select from approximately 200 RAL powder coat color options to best match your home.



Actual door colors may vary from brochure photos due to fluctuations in the printing process. Always request a color sample from your Overhead Door™ Distributor for accurate color matching.

Panel layout

Door width	Number of panels
to 11'11" (3632 mm)	3
12'0" to 14'11" (3658 mm to 4547 mm)	4
15'0" to 16'2" (4572 mm to 4928 mm)	5

Section stack

Door height	Number of sections
to 8'6" (2591 mm)	4
8'7" to 10'1" (2616 mm to 3073 mm)	5
10'2" to 12'1" (3099 mm to 3683 mm)	6
12'2" to 14'1" (3708 mm to 4293 mm)	7
14'2" to 16'1" (4318 mm to 4902 mm)	8

ALUMINUM DOOR SYSTEMS MODEL 521

is perfect for environments where maximum light infiltration and/or visual access is required. Designed to fit openings up to 26'2" (7976 mm) wide and 20'1" (6121 mm) high, the 521 Model features a wide, 2 11/16" (68 mm) center stile, a 2 3/8" (60 mm) or 3 3/4" (95 mm) top rail, and 3 3/4" (95 mm) or 4 1/2" (114 mm) bottom rail. A variety of glazing choices, finishes and special options are available.

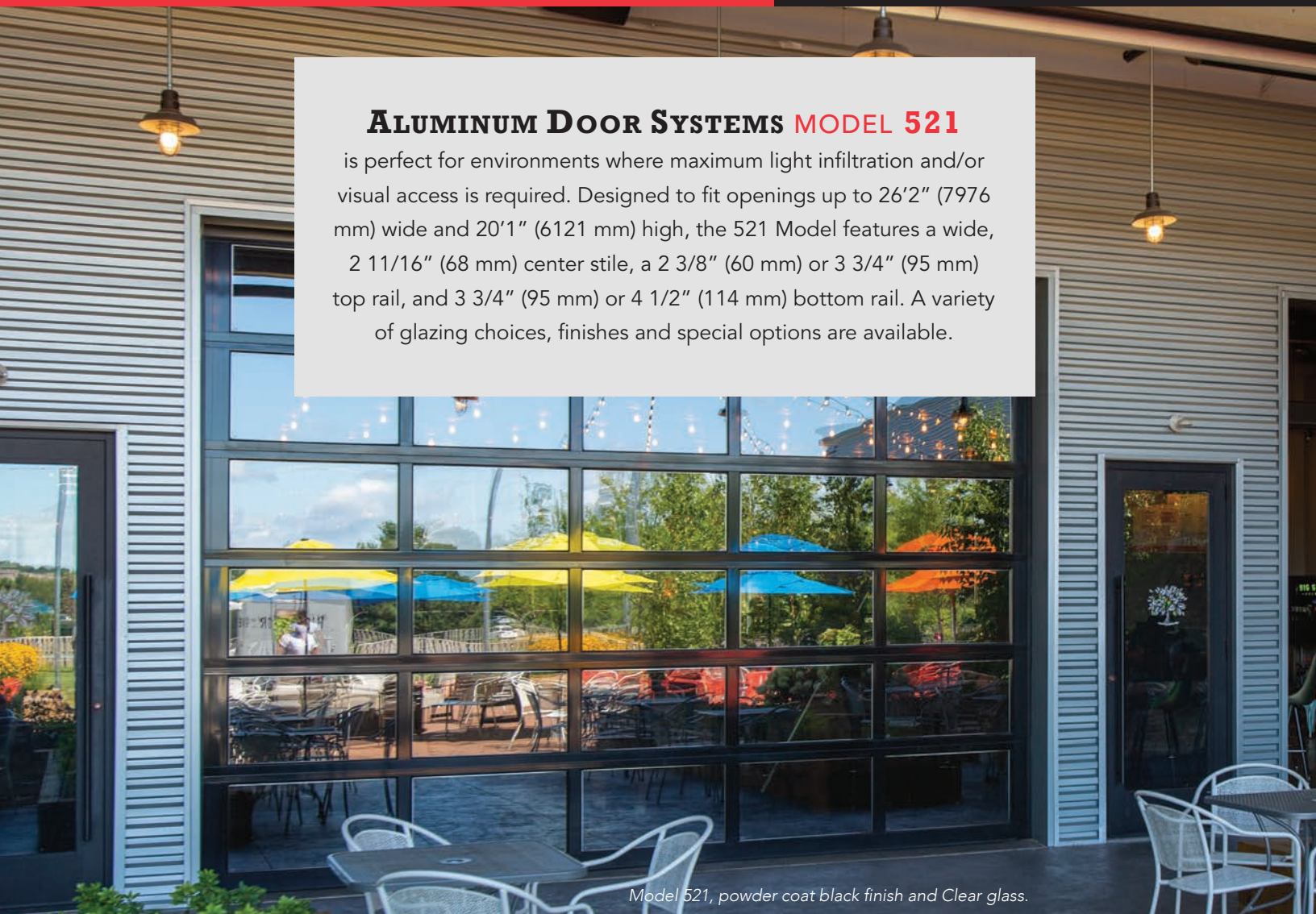

Model 521, powder coat black finish and Clear glass.

Optional polyurethane insulation for stiles and rails up to 18'2" wide

1/2" insulated glazing unit	Door R-value (K m²/W)
DSB- clear, tempered, obscure	2.87
Clear polycarbonate	2.93
DSB - Solar Bronze	3.17
DSB - Low E coating	3.43
SolarBan 70XL argon filled	4.09
Multi-wall polycarbonate	Door R-value (K m²/W)
1/4" thick unit	2.75
3/8" thick unit	3.21
5/8" thick unit	3.48
Insulated panels	Door R-value (K m²/W)
3/8" EPS solid panels	2.60

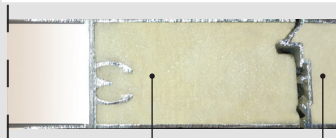

Polyurethane filled rails and stiles

*R-value: Overhead Door Corporation uses a calculated door section R-value for our insulated doors.



Standard features at a glance

Section thickness	1 3/4" (45 mm)
Maximum standard height	20'1" (6121 mm)
Maximum standard width	26'2" (7976 mm)
Material	Extruded 6061-T6 aluminum
Standard finish	204R-1 clear anodized (painted white at no charge)
Center stile width	2 11/16" (68 mm)
End stile width	3 5/16" (85 mm)
Top rail width	2 3/8" (60 mm) or 3 3/4" (95 mm)
Top intermediate rail width	2 1/8" (54 mm)
Bottom intermediate rail width	1 19/32" (40 mm)
Bottom rail width	3 3/4" (95 mm) or 4 1/2" (114 mm)
Weatherseals	Bottom, flexible PVC
Standard springs	10,000 cycle
Track	2" (51 mm)
Mounting	Angle
Operation	Manual pull rope
Hinges and fixtures	Galvanized steel
Lock	Galvanized, interior-mounted single unit
Warranty	1-Year Limited; 3-Year Limited on powder coat finish

Options

- Glazing options[†]: 1/8" (3 mm) DSB; 1/8" (3 mm) or 1/4" (6 mm) acrylic; 1/8" (3 mm) or 1/4" (6 mm) tempered; 1/8" (3 mm) or 1/4" (6 mm) clear polycarbonate; 1/4" (6mm) and 3/8" twin-wall polycarbonate, 5/8" triple-wall polycarbonate; 1/4" (6 mm) 3/8" (10 mm) and 5/8" (16 mm) twin-wall polycarbonate, triple-wall polycarbonate 1/4" (6 mm) wire glass; 1/2" (12 mm) insulated glass
- Electric operator or chain hoist
- Bottom sensing edge
- 3" track
- Bracket mounting (not available on full vertical door tracks)
- Higher-cycle springs in 25k, 50k, 75k, 100k cycles
- Exhaust ports
- Four-section pass door
- Wind load and impact rated door available
- Posi-tension drums
- Bronze anodization
- Powder coat finish
- Pass door

[†]Contact your local Overhead Door™ Distributor for special glazing requirements. Verify 1/4" (6 mm) glass applications with factory.

Structure options

Anodized finishes



Clear (standard)



Light Bronze

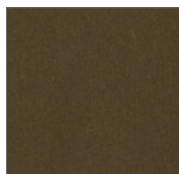

Medium Bronze

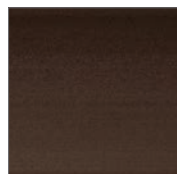

Dark Bronze

Wood grain powder coat finishes*

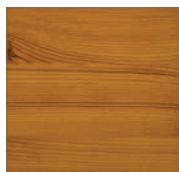

Knotty Pine

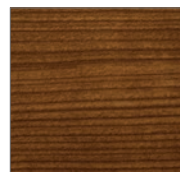

Cherry

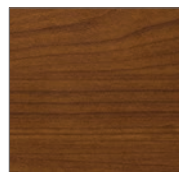

Cherry with Flame

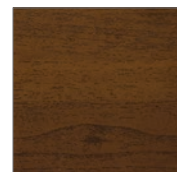

Dark Walnut

Powder coat finishes

Select from approximately 200 RAL powder coat color options to best match your home.



*Wood grain availability dependent upon location.

Actual door colors may vary from brochure photos due to fluctuations in the printing process. Always request a color sample from your Overhead Door™ Distributor for accurate color matching.

Panel layout	
Door width	Number of panels
to 9'2" (to 2794 mm)	2 or 3 (standard)
9'3" to 12'2" (2819 mm to 3708 mm)	3
12'3" to 16'2" (3734 mm to 4953 mm)	4
16'3" to 18'2" (4978 mm to 5537 mm)	4 or 5 (standard)
18'3" to 19'2" (5562 mm to 5842 mm)	5
19'3" to 20'11" (5867 mm to 6375 mm)	6**
21'0" to 23'11" (6401 mm to 7290 mm)	8**
24'0" to 26'2" (7315 mm to 7976 mm)	10**

Section stack	
Door height	Number of sections
to 8'6" (2591 mm)	4
8'7" to 10'1" (2616 mm to 3073 mm)	5
10'2" to 12'1" (3099 mm to 3683 mm)	6
12'2" to 14'1" (3708 mm to 4293 mm)	7
14'2" to 16'1" (4318 mm to 4902 mm)	8
16'2" to 18'1" (4928 mm to 5512 mm)	9
18'2" to 20'1" (5537 mm to 6121 mm)	10

**Special construction. Consult your local Overhead™ Door Distributor for additional information.

ALUMINUM DOOR SYSTEMS MODEL 522

This aluminum full-view door is ideal for restaurants, auto dealerships and any application where the door needs to integrate seamlessly with the aesthetics of the building.

Model 522, Mirrored Bronze glass



Standard features at a glance

Section thickness	1 3/8" (35 mm)
Maximum standard height	14'1" (4318 mm)
Maximum standard width	18'2" (5486 mm)
Material	6063-T6 aluminum
Standard finish	White, Black or Bronze Powder Coat
Center stile width	3" (76 mm)
End stile width	3 1/2" (89 mm)
Top rail width	3 1/2" (89 mm)
Top intermediate rail width	1 5/8" (41 mm)
Bottom intermediate rail width	1 3/8" (35 mm)
Bottom rail width	3 1/2" (89 mm)
Standard springs	10,000 cycle
Track	Provide track as recommended by manufacturer to suit loading required and clearances available
Mounting	Angle
Operation	Manual pull rope
Hinges and fixtures	Galvanized steel
Lock	Galvanized, interior-mounted single unit
Warranty	1-Year Limited

Options

- Springs: 25,000, 50,000, 75,000 or 100,000 cycles
- Weather stripping: jamb and header seals
- White or Black powder coat track

Glass options



Opaque White

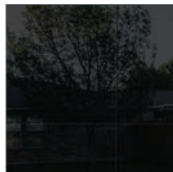

Opaque Black



Mirrored Gray

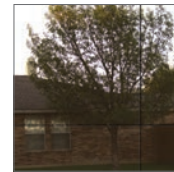

Mirrored Bronze



Translucent Black

Structure options

Powder Coat Finishes



White

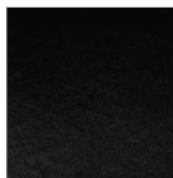

Black



Bronze

Anodized Finishes



Black



Bronze

Actual colors may vary from brochure due to fluctuations in the printing process. Always request a color sample from your Overhead Door™ Distributor for accurate color matching.

Aluminum and glass pairing

Aluminum options

White Powder Coat

Black Powder Coat / Bronze Powder Coat /
Black Anodized / Bronze Anodized

Glass color

Opaque White

Opaque Black / Mirrored Gray / Mirrored Bronze /
Translucent Black

Each door is unique and built to order, therefore a slight deviation in glass alignment is possible. These doors may become hot to the touch in sustained hot weather. See website for door sizes, section selection and other details.

Track detail

Any of the following track configurations can be selected for 511, 521 and 522 Aluminum door models.

O.H.=Opening height L.C.=Lift clearance D.H.=Door height

Standard lift track Lift clearance track Standard Full vertical track

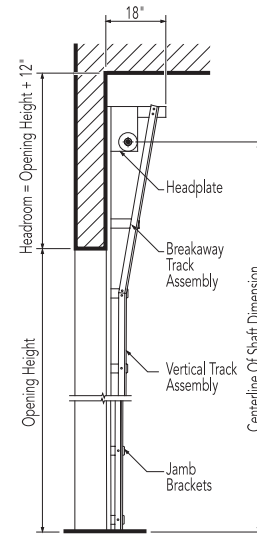
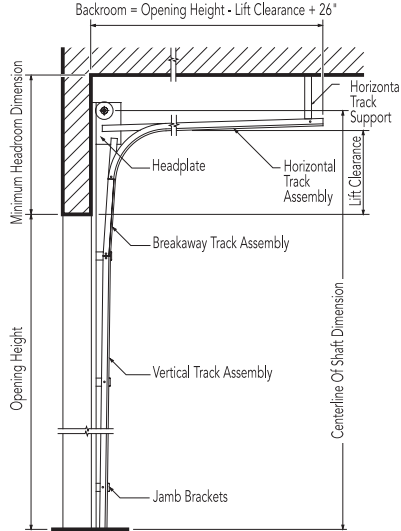
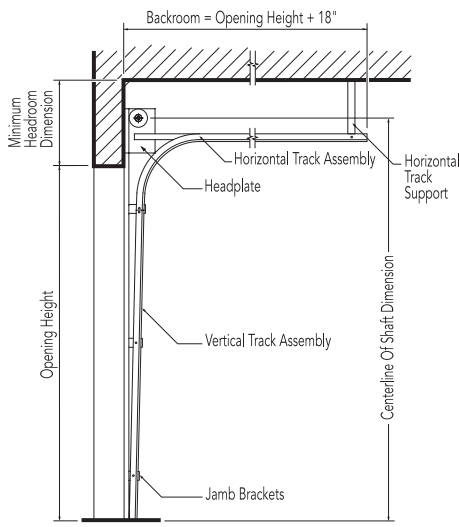

2" (51 mm) Track [15" (381 mm) radius]		
Door height	Centerline of shaft	Minimum headroom
Thru 12'0" (3658 mm)	O.H. + 11 5/8" (295 mm)	14 1/4" (362 mm)
Thru 16'0" (4877 mm)	O.H. + 12 5/8" (321 mm)	20 1/2" (521 mm)

2" (51 mm) Track [15" (381 mm) radius]		
Door height	Centerline of shaft	Minimum headroom
Thru 12'0" (3658 mm)	O.H. + L.C. + 5 5/8" (143 mm)	L.C. + 8 3/4" (222 mm)
Thru 16'0" (4877 mm)	O.H. + L.C. + 5 5/8" (143 mm)	L.C. + 11 1/4" (286 mm)

2" (51 mm) Track [15" (381 mm) radius]		
Door height	Centerline of shaft	Minimum headroom
Thru 11'0" (3353 mm)	O.H. + O.H. + 3/8" (10 mm)	O.H. + 10 1/4" (260 mm)
Thru 16'0" (4877 mm)	O.H. + O.H. + 3/8" (10 mm)	O.H. + 10 1/4" (260 mm)

3" (76 mm) Track [15" (381 mm) radius]		
Door height	Centerline of shaft	Minimum headroom
Thru 18'0" (5486 mm)	O.H. + 14 5/8" (372 mm)	18" (457 mm)
Thru 32'0" (9754 mm)	O.H. + 16 7/8" (429 mm)	21 1/2" (546 mm)

3" (76 mm) Track [15" (381 mm) radius]		
Door height	Centerline of shaft	Minimum headroom
Thru 22'0" (6706 mm)	O.H. + L.C. + 6 5/8" (168 mm)	L.C. + 11 1/2" (292 mm)
Thru 32'0" (9754 mm)	O.H. + L.C. + 6 5/8" (168 mm)	L.C. + 12 1/4" (311 mm)

3" (76 mm) Track [15" (381 mm) radius]		
Door height	Centerline of shaft	Minimum headroom
Thru 18'0" (5486 mm)	O.H. + O.H. + 3/8" (10 mm)	O.H. + 10 1/4" (260 mm)

Low headroom track Springs to front

Low headroom track Springs to rear

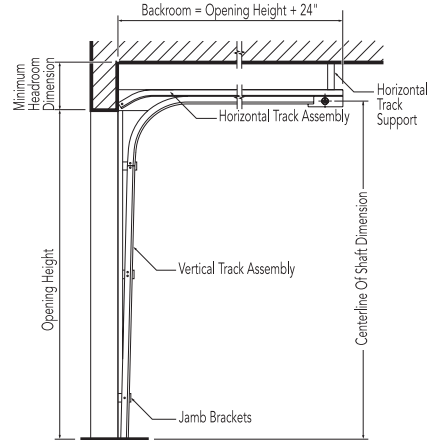
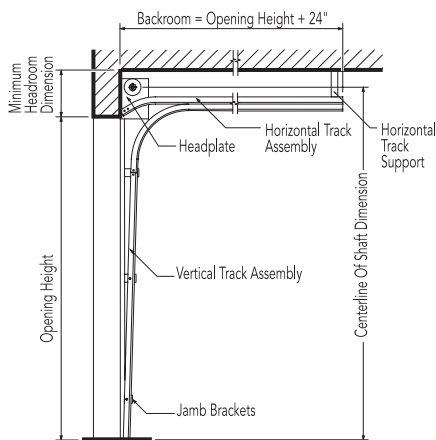

2" (51 mm) Track [15" (381 mm) radius]		
Door height	Centerline of shaft	Minimum headroom
Thru 12'0" (3658 mm)	D.H. + 8" (203 mm)	11 3/4" (299 mm)
Thru 16'0" (4877 mm)	D.H. + 8" (203 mm)	12 1/2" (318 mm)

3" (76 mm) Track [15" (381 mm) radius]		
Door height	Centerline of shaft	Minimum headroom
Thru 12'0" (3658 mm)	D.H. + 9" (229 mm)	13" (330 mm)
Thru 32'0" (5486 mm)	D.H. + 9" (229 mm)	13 3/4" (349 mm)

2" (51 mm) Track [15" (381 mm) radius]		
Door height	Centerline of shaft	Minimum headroom
Thru 12'0" (3658 mm)	O.H. + 2" (51 mm)	7 1/2" (191 mm)
Thru 16'0" (4866 mm)	O.H. + 2" (51 mm)	8" (203 mm)

3" (76 mm) Track [15" (381 mm) radius]		
Door height	Centerline of shaft	Minimum headroom
Thru 18'0" (5486 mm)	O.H. + 6 3/4" (171 mm)	9 3/4" (248 mm)



Framing and pad detail

Framing and pad details for common installation of Aluminum doors in steel, wood, concrete and masonry jambs are provided here. If you require additional information or have special project requirements, refer to the Architectural Design Manual, (www.overheaddoor.com/ADM/base.html) Group or your local Overhead Door™ Distributor.

Steel jambs

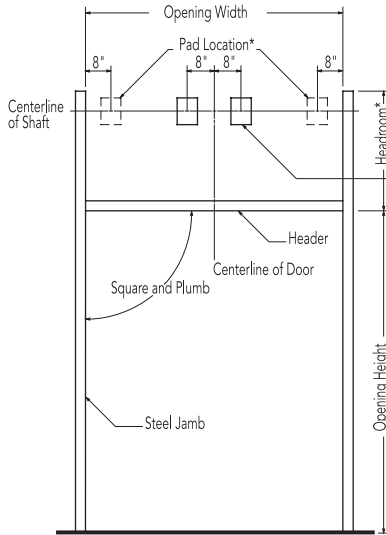

* Pad Location for additional shaft support brackets for doors over 18'3" wide

Wood jambs

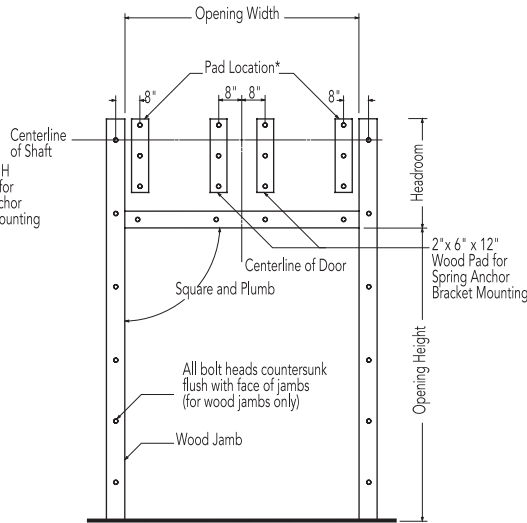

* Pad Location for additional shaft support brackets for doors over 18'3" wide

Concrete/masonry jambs

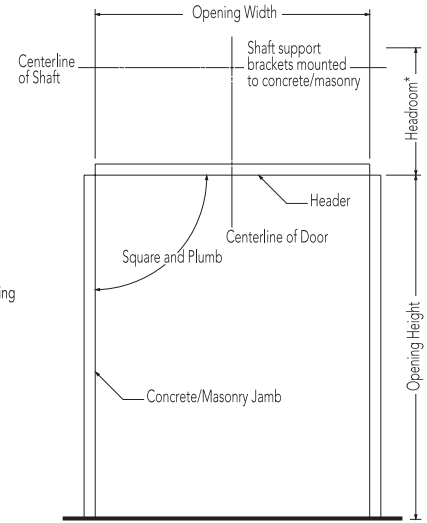

2" (51 mm) track

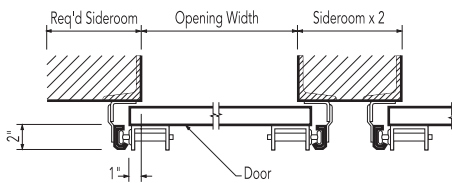

2" (51 mm) track

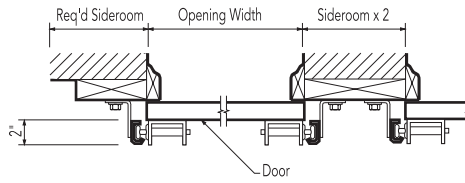

2" (51 mm) track

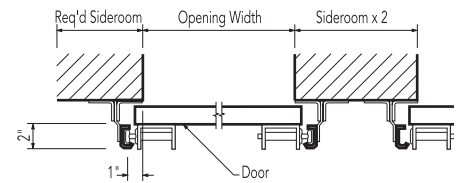

3" (76 mm) track

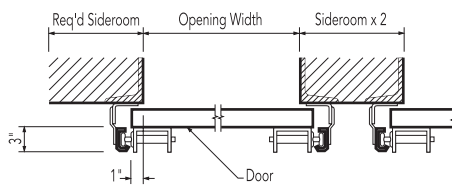

3" (76 mm) track

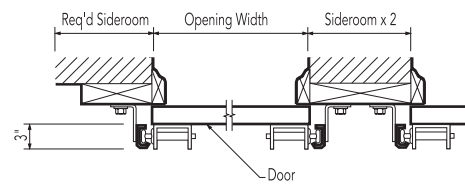

3" (76 mm) track

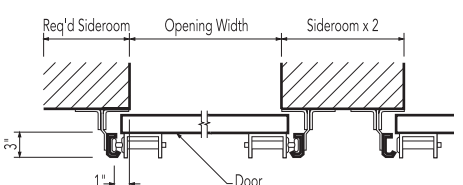

Minimum required sideroom

Track type	2" Track (51 mm)	3" Track (76 mm)
Standard lift	4 1/2" (114 mm)	6 1/2" (165 mm)
Low headroom	9" (229 mm)	10" (254 mm)
Lift clearance	4 1/2" (114 mm)	6 1/2" (165 mm)
Full vertical	4 1/2" (114 mm)	6 1/2" (165 mm)

Minimum required sideroom

Track type	2" Track (51 mm)	3" Track (76 mm)
Standard lift	3 1/2" (89 mm)	5 1/2" (140 mm)
Low headroom	8" (203 mm)	9" (229 mm)
Lift clearance	3 1/2" (89 mm)	5 1/2" (140 mm)
Full vertical	3 1/2" (89 mm)	5 1/2" (140 mm)

Minimum required sideroom

Track type	2" Track (51 mm)	3" Track (76 mm)
Standard lift	4 1/2" (114 mm)	6 1/2" (165 mm)
Low headroom	9" (229 mm)	10" (254 mm)
Lift clearance	4 1/2" (114 mm)	5 1/2" (140 mm)
Full vertical	4 1/2" (114 mm)	5 1/2" (140 mm)

Electric operators

We offer a broad line of electric operators to suit new construction and retrofit applications, as well as unusual or special requirements. In order to improve safety and enhance door and motor life, industry quality assurance guidelines recommend the choice of a single manufacturer for both door and operator applications.

We are one of the only national manufacturers to offer a full line of commercial and industrial doors and operators specifically designed for integral applications.

Model RHX®

Model RHX® is a heavy duty commercial operator designed to operate doors up to 24' (7315 mm) in height and 3696 pounds (1676 kg). Available as either a trolley, sidemount or centermount.



Model RMX®

Model RMX® is our most advanced medium-duty operator. It is designed for quicker installation and hassle-free operation and operates doors up to 14' (4267 mm) in height and 620 pounds (282 kg). It is available as a trolley-type or side-mounted unit.



Model RSX®

Model RSX® is a standard duty commercial operator designed to operate doors up to 24' (7315 mm) in height and 1620 pounds (735 kg). It offers unique features like LimitLock®, SuperBelt™ and 16 digit menu setup.



Operator control options

- Push-button, key or combination stations; surface- or flush-mounted for interior and/or exterior locations
- Vehicle detectors, key card reader, photocell and door timer controls
- Treadle or pull switch stations
- Telephone entry and coded keyboard stations
- Universal programmable door timer
- Radio control systems (24 VAC or 120 VAC)
- Explosion and dust ignition-proof systems

Electric operator selection guide										
	Horsepower/ Newtons	Max. height of door	Max. weight of door	Super Belt™/ Polybelt	Worm gear	Adjustable clutch	Totally enclosed	Continuous duty	Explosion proof	Mounting type
RHX®	1/2 HP, 3/4 HP 1 HP, 3 HP	24' (7315 mm)	3696 lbs (1676 kg)		•	•		•	•	T, S, C
RSX®	1/2 HP, 3/4 HP 1 HP	24' (7315 mm)	1620 (735 kg)	•		•	•	•		T, S, C
RMX®	1/2 HP	14' (4267 mm)	620 (281 kg)	•						T, S

Mounting options:
T=Trolley S=Side mount C= Center mount

Safety recommendations

We strongly recommend the use of a primary safety device as defined by UL325 2010. A primary safety device can be approved monitored photo-eyes or an approved monitored sensing edge. If a primary safety device is not installed, a constant contact control switch must be used to close the door. Contact your Overhead Door™ Distributor for more information.



Mounting details

**Trolley-type (Drawbar)
RMX®, RSX®, RHX®**

Trolley-type (Drawbar) operators feature a power unit mounted between, above and to the rear of the horizontal tracks. The drawbar drive provides positive control of the door at all times, making this operator the preferred choice whenever possible. Maximum door width is 20' per drawbar. Door width over 20' requires dual drawbar installation. Available on Models RMX®, RSX® and RHX®.

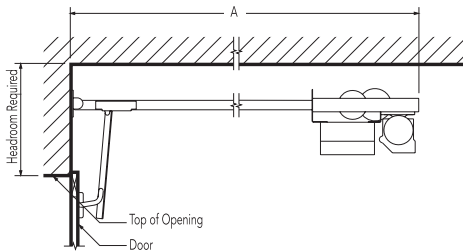

**Side mount type (Jackshaft)
RMX®, RSX®, RHX®**

Side-mounted (Jackshaft) RMX®, RSX®, and RHX® operators feature a power unit mounted on the inside front wall and connected to the crosshead shaft, with an adjustable coupling or drive chain and sprockets.

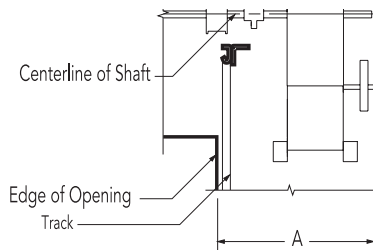

**Center mount type/Jackshaft
RSX®, RHX®**

Center-mounted (Jackshaft) operators feature a power unit on the front wall above the door opening. No additional backroom is required. Available on models RSX® and RHX®.

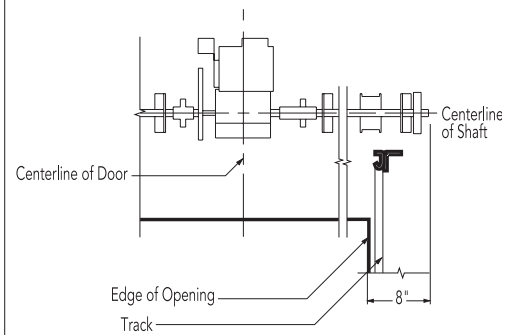

Minimum headroom requirements	
RMX®	Track requirements +4 1/2" (114 mm)
RSX®	Track requirements +5" (127 mm)
RHX®	Track requirements +5" (127 mm)

Depth requirements - "A" dimension (backroom)	
RMX®	Door height +4' 0" (1219 mm)
RSX®	Door height +4' 0" (1219 mm)
RHX®	Door height +4' 10" (1219 mm)

"A" dimension - minimum (sideroom)		
	2" track (51 mm)	3" track (76 mm)
RMX®	18 1/2" (470 mm)	19 1/2" (495 mm)
RSX®	21" (533 mm)	22" (559 mm)
RHX®	21" (533 mm)	22" (559 mm)

Minimum headroom requirements	
RSX®	Track requirements +14" (356 mm)
RHX®	Track requirements +23 5/8" (600 mm)



Model 521, solid panel, custom powder coat finish

The original, innovative choice for unequalled quality and service.

Overhead Door Corporation pioneered the sectional garage door industry, inventing the first sectional garage door in 1921 and the first electric door operator in 1926. Today, we continue to be the industry leader through the strength of our product innovation, superior craftsmanship and outstanding customer support, underscoring a legacy of quality, expertise and integrity. That's why design and construction professionals specify Overhead Door™ products more often than any other brand. Our family of over 400 Overhead Door™ Distributors across the U.S. and Canada not only share our name and logo, but also our commitment to excellence.



INDUSTRY LEADING
COMMERCIAL & INDUSTRIAL SOLUTIONS

Overhead Door Company of the Meadowlands & NYC



www.overhead-doors.com | Tel. 973-471-4060 | info@dockndoor.com

©2021 Overhead Door Corporation. Overhead Door is a trademark and the Red Ribbon logo is a registered trademark of Overhead Door Corporation. All other trademarks are property of their rightful owners. Consistent with our policy of continuing product improvement, we reserve the right to change product specifications without notice or obligation. C900-069 03/21